

Article number: 51030451000010

Description: Vibration damper GS-M2  
100x40x2000-5, NR shore 57

## Measures

---

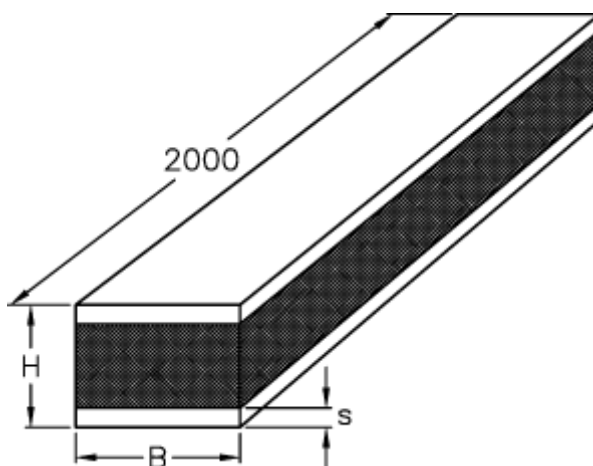

B = 100  
H = 40  
S = 5